

Ø10mm
80 G-72 2F

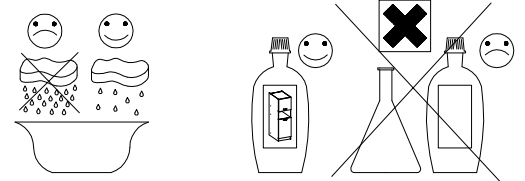

max. 5kg
KUH.30011
KUH.40022

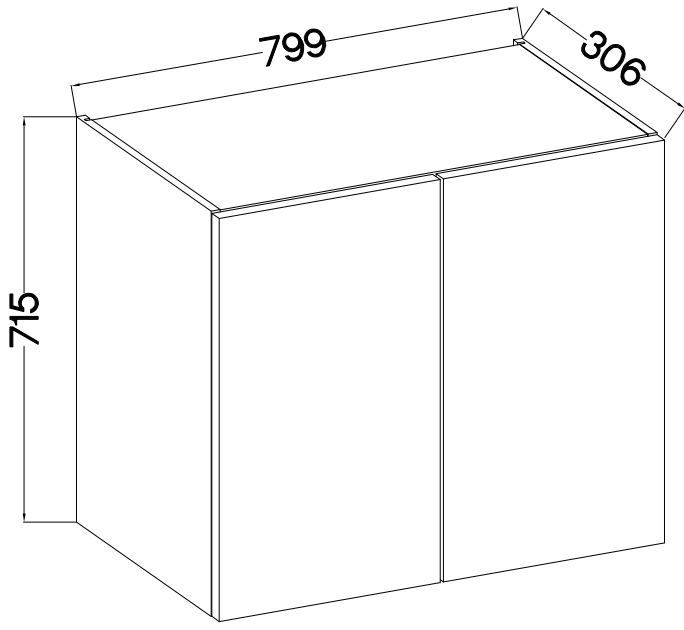

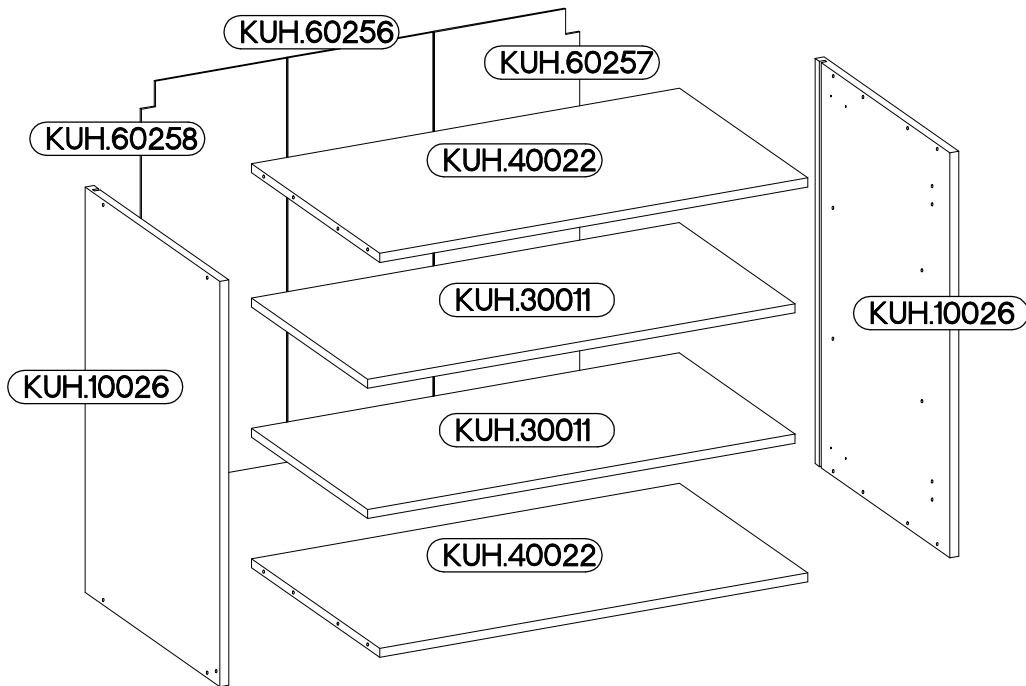
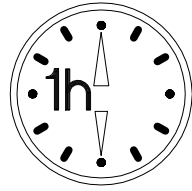

Ersatzteil Nummer	Dimension
KUH.10026 x2	715x290x16
KUH.30011 x2	766x250x16
KUH.40022 x2	767x276x16
KUH.60256	713x260x2,5
KUH.60257	713x260x2,5
KUH.60258	713x260x2,5

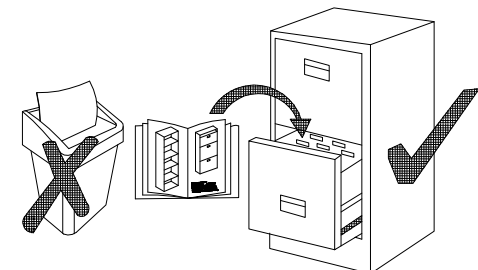
+8x30mm A 8	6,4 x 50mm B 8	E1 8	+35/0mm HG 4			
+5/19mm J 8	K 2	L1=680mm L1 2	O 1	+3.5x13mm P5 8	+3.0x20mm P7 15-20	+4.0x30mm P8 4



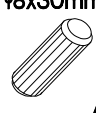

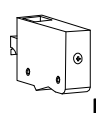
ISM-KUH-01145

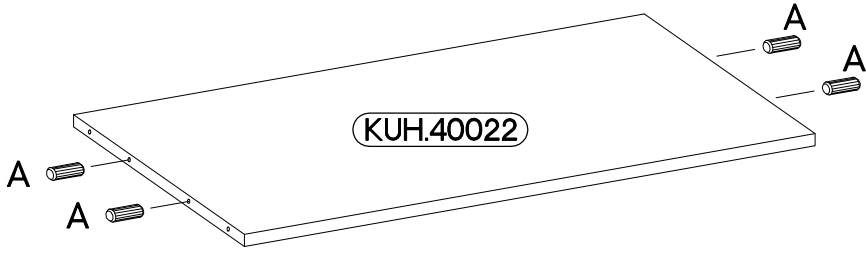
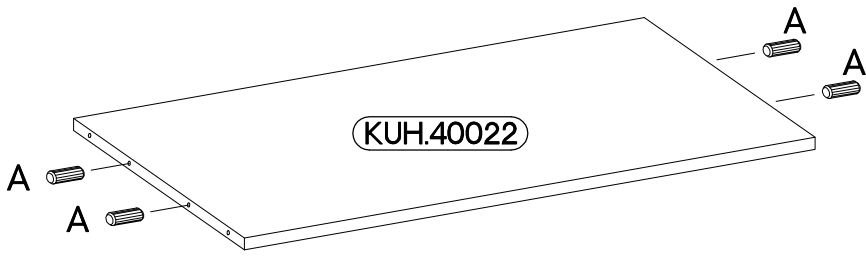
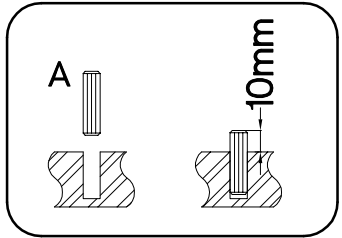
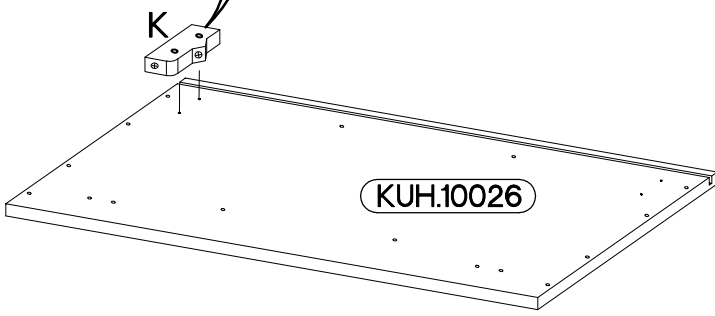
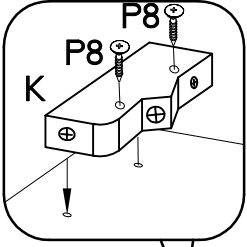
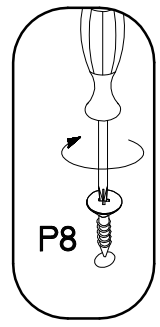
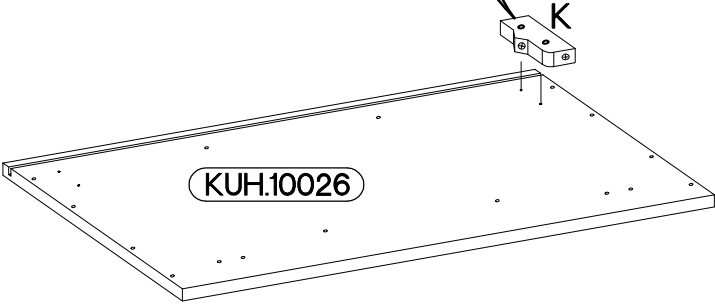
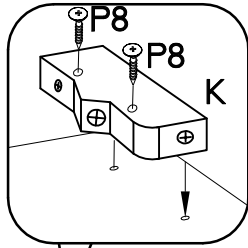
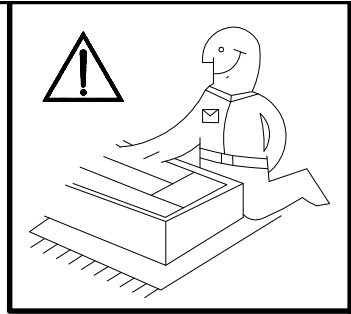
 ‡8x30mm A	 ‡4.0x30mm P8	 K
8	4	2



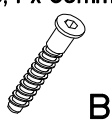
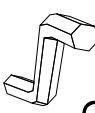

2

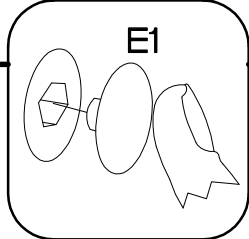
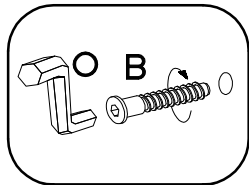
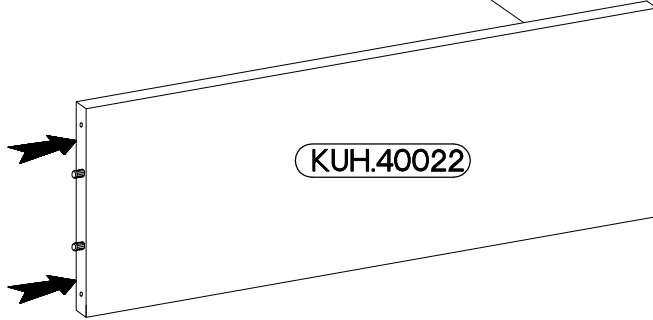
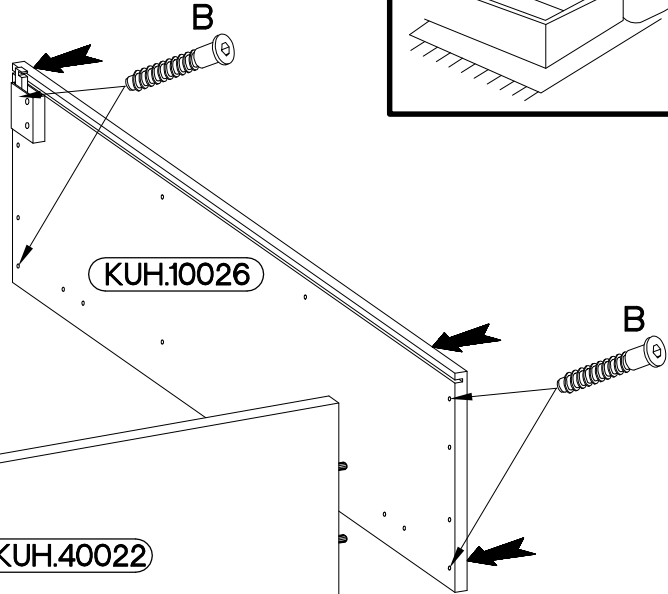
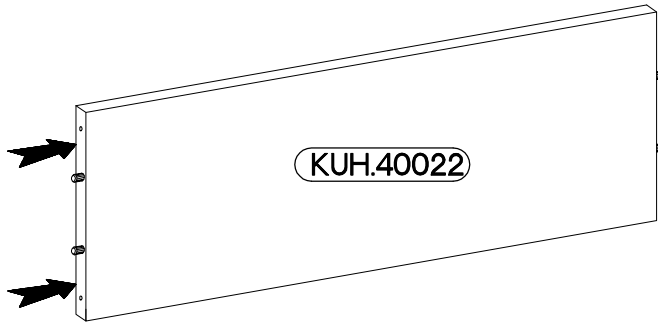
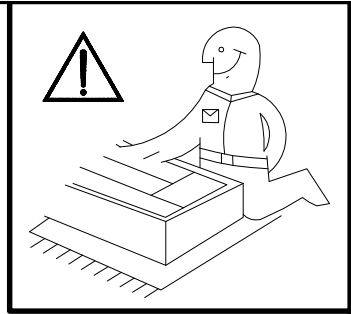
6,4 x 50mm		
		
B	O	E1
4	1	4

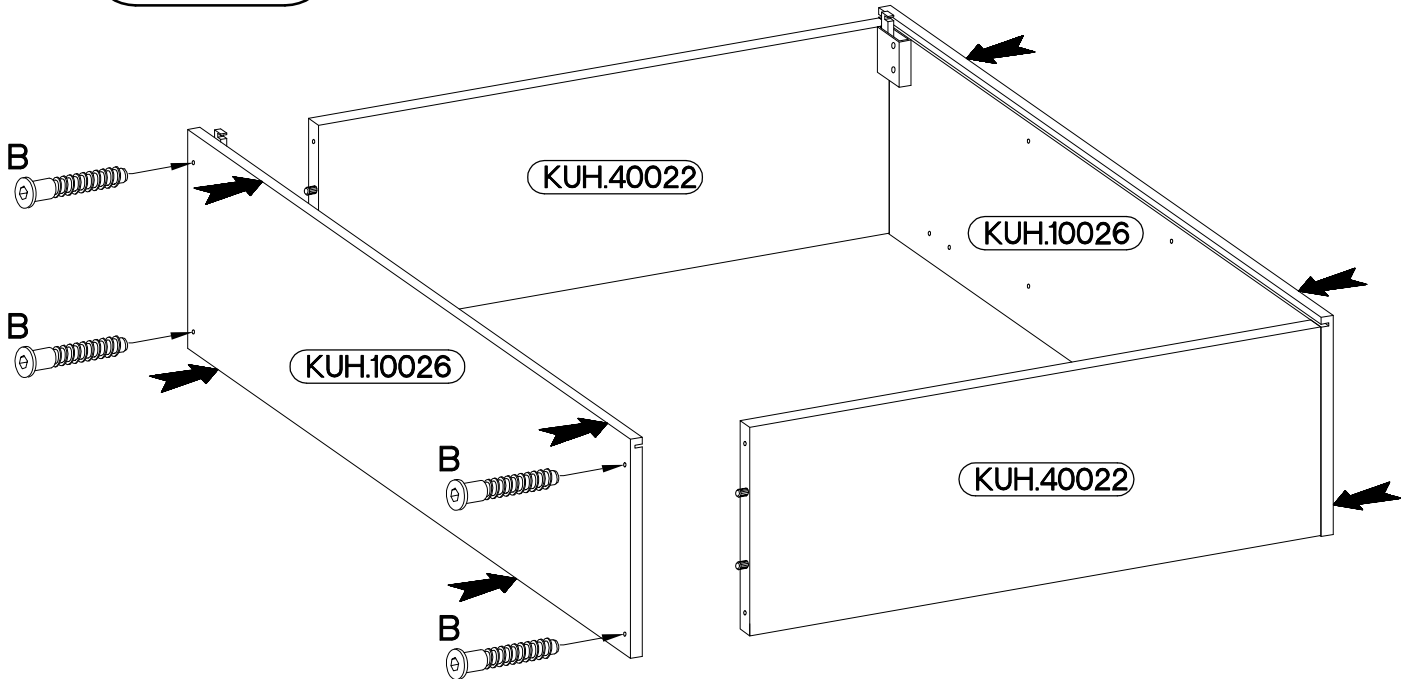

3

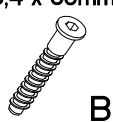
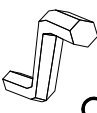

6,4 x 50mm		
		
B	O	E1
4	1	4

4

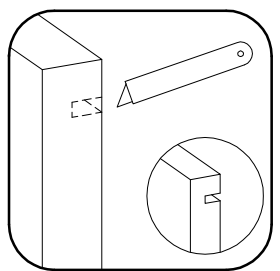
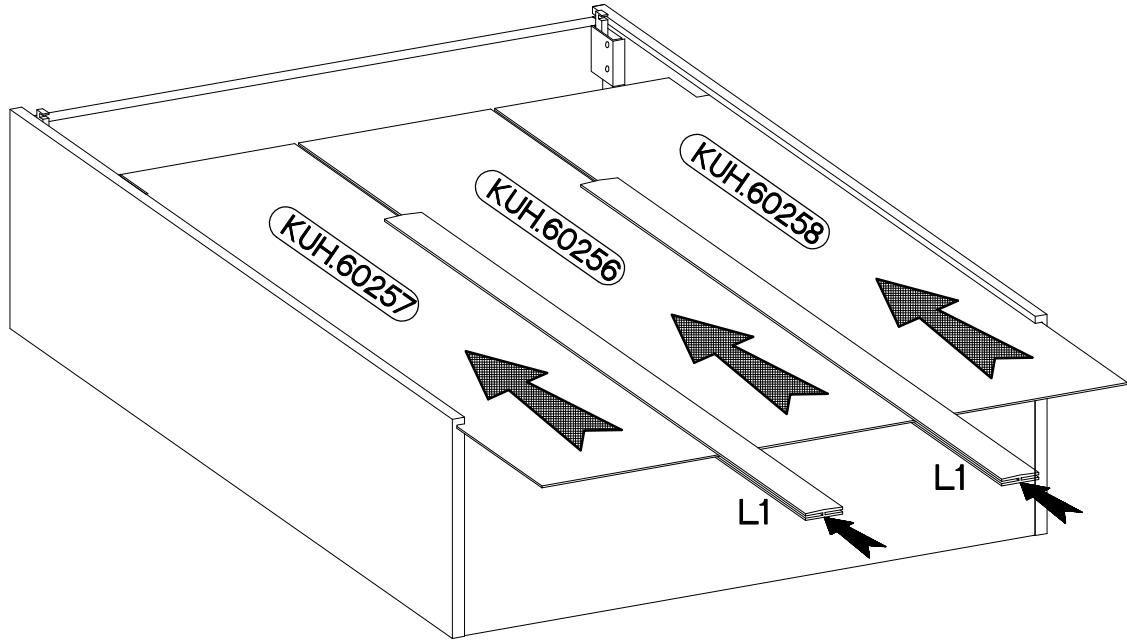
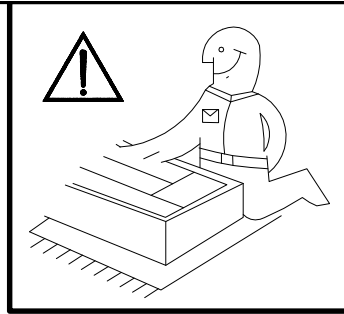
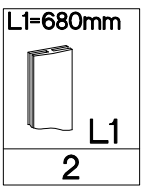

5

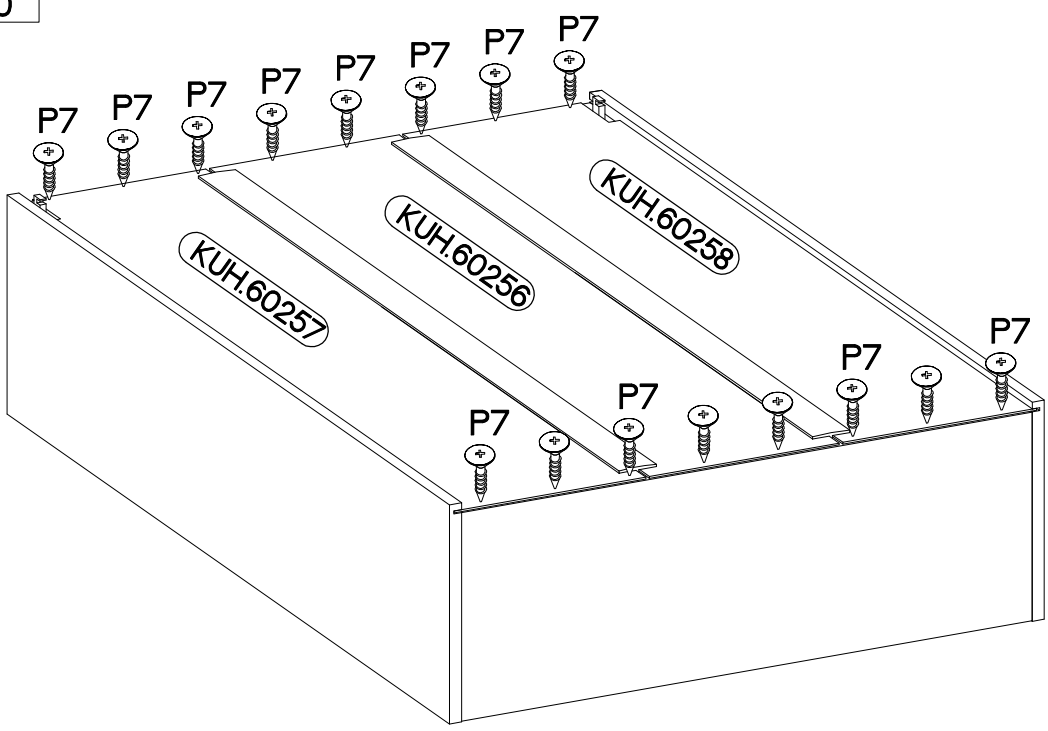
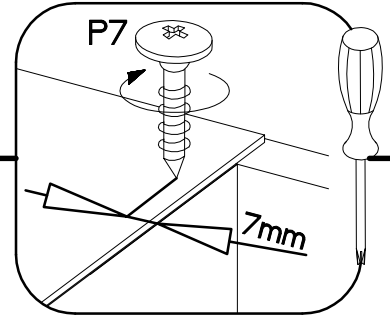
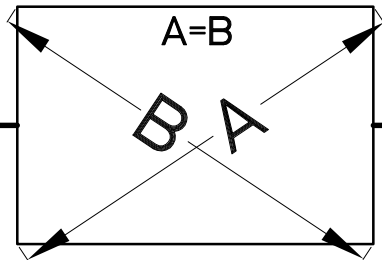
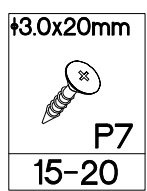

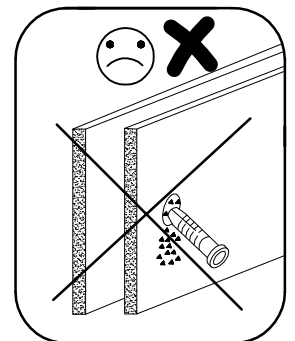
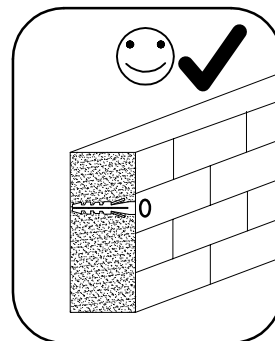
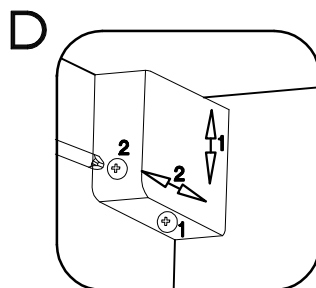
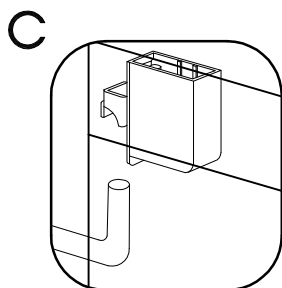
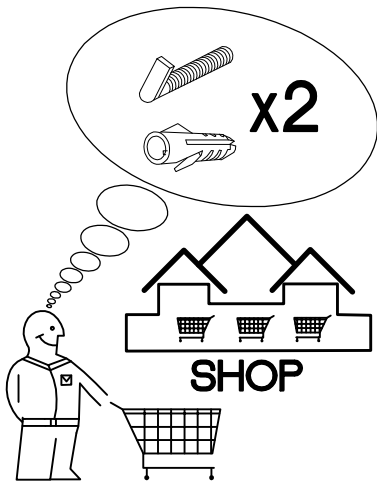
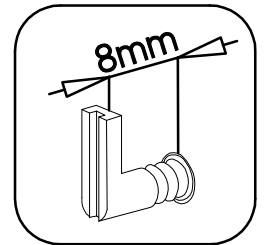
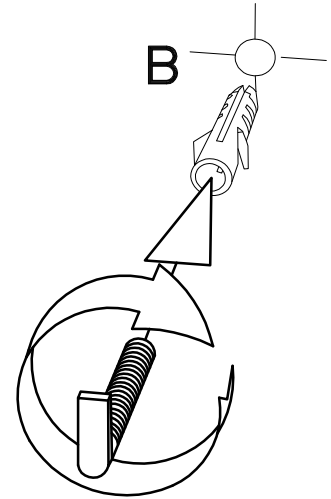
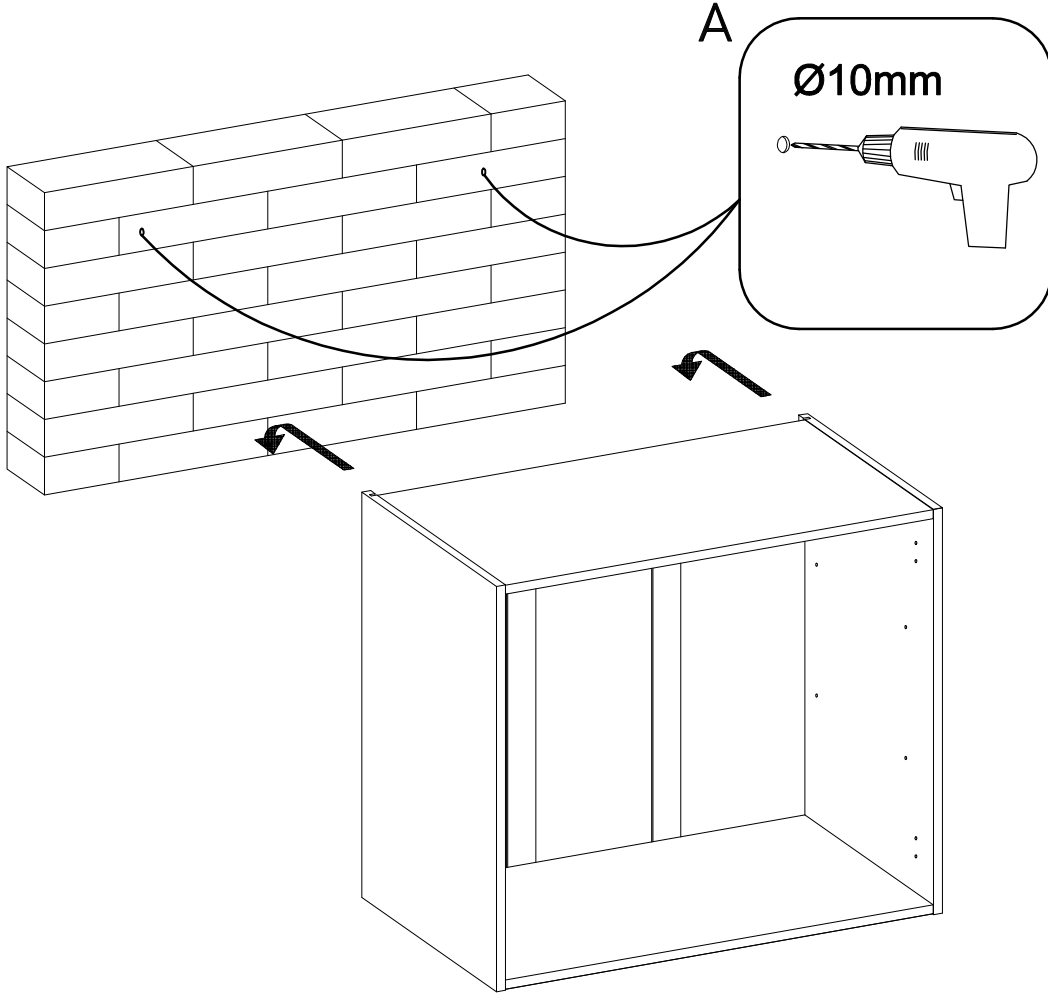
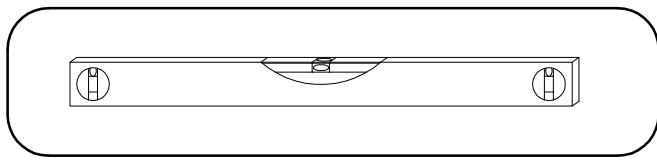

7

±5/19mm
J
8

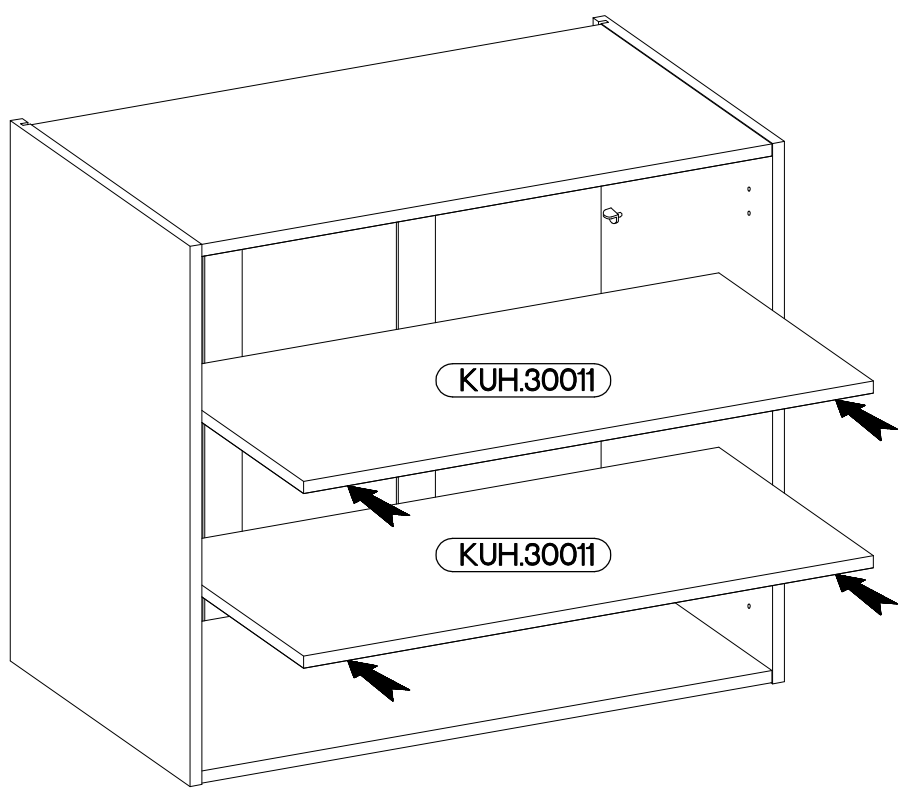
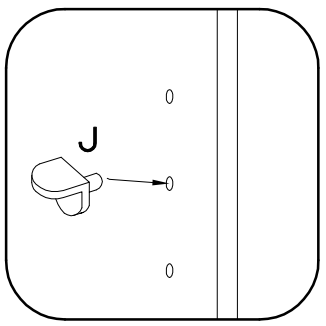

8

FRONT

