

Nr	Ausmaß			St
2	1000	200	22	1
3	672	180	16	1
4	672	180	16	1
5	330	669	20	3
6	647	158	16	1
7	647	158	16	1
8	309	155	16	4
9	316	155	16	2
10	966	159	16	1
11	669	330	2	1
12	669	324	2	1
13	669	324	2	1

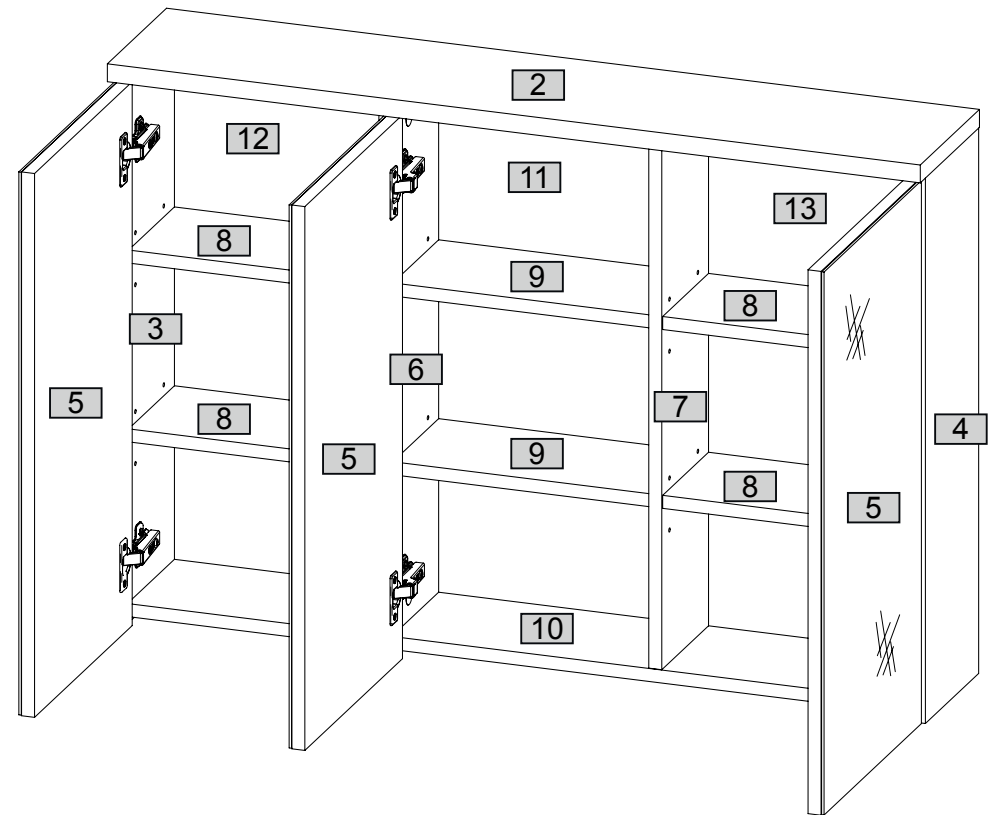

1

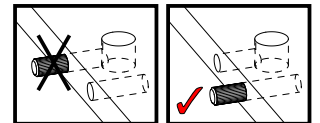
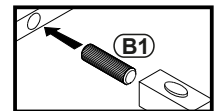
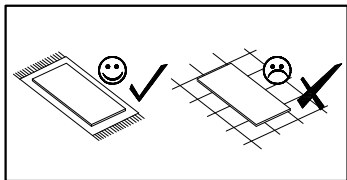
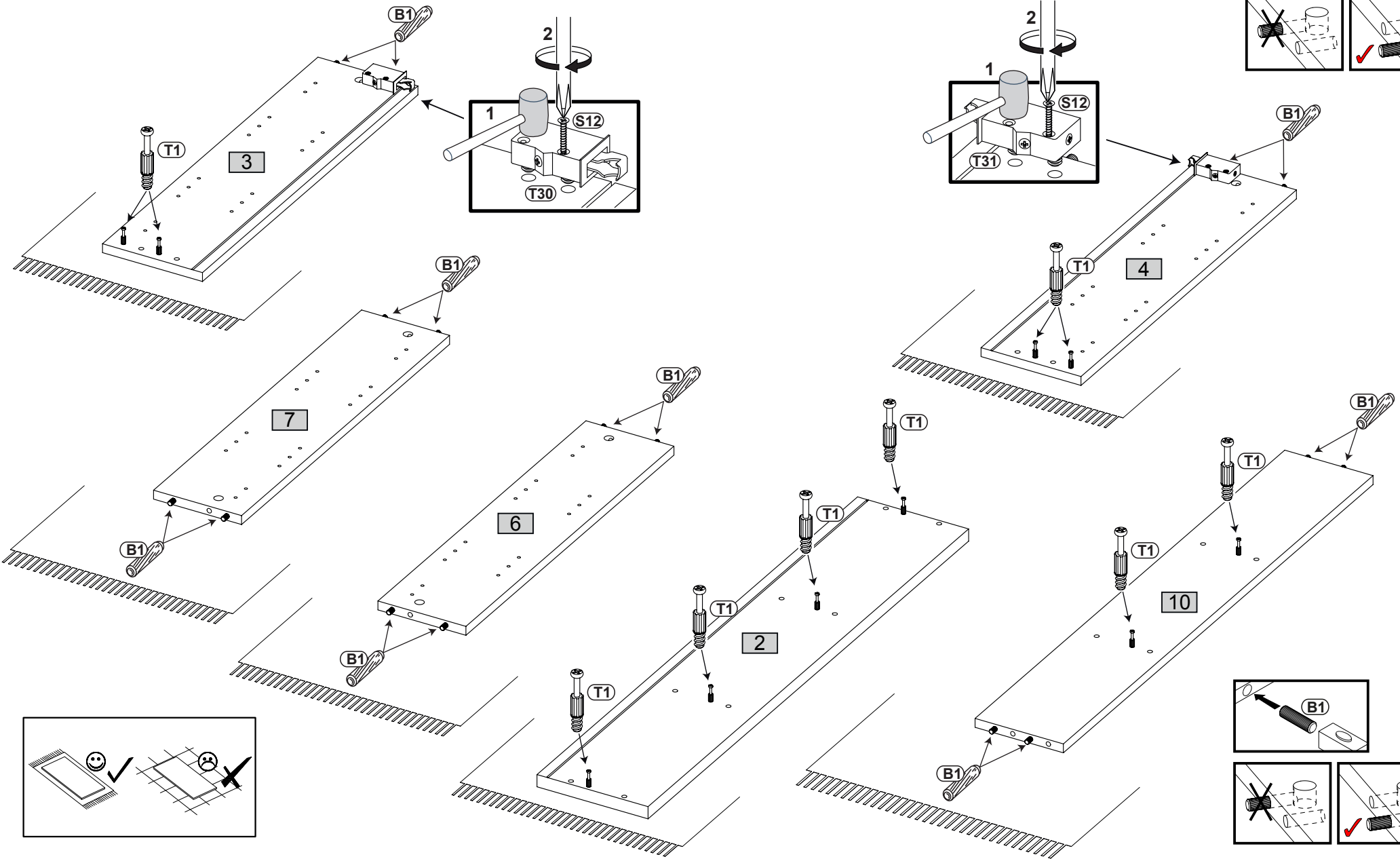
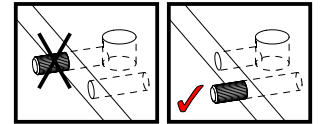
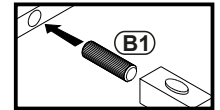
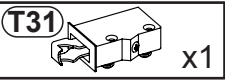
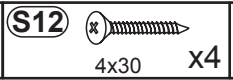
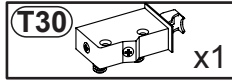
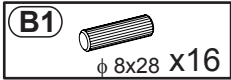
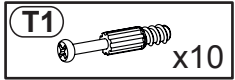

2

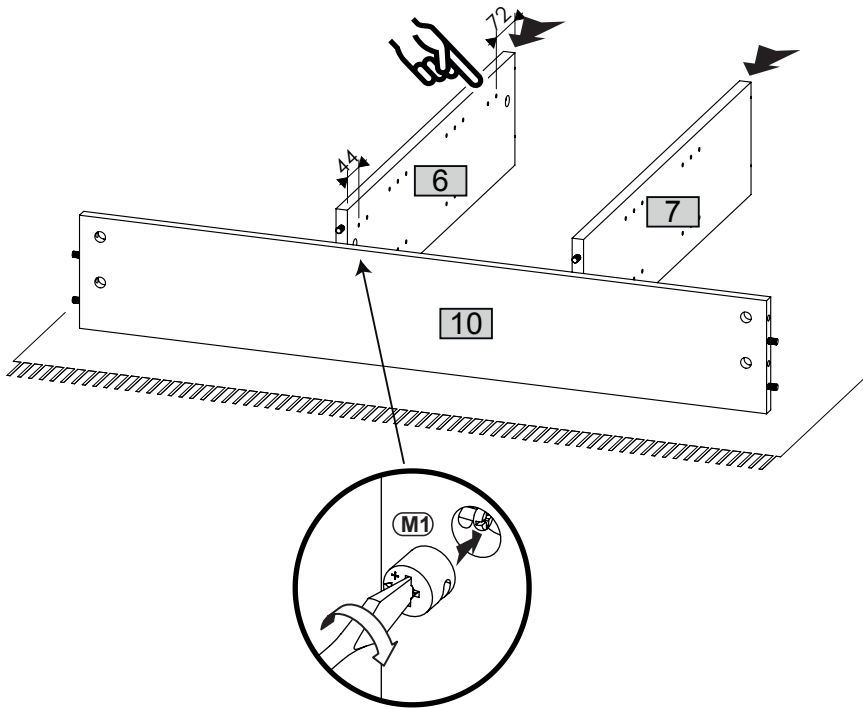

3

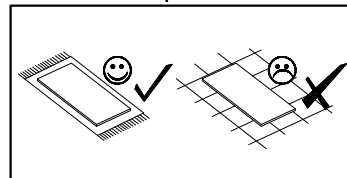
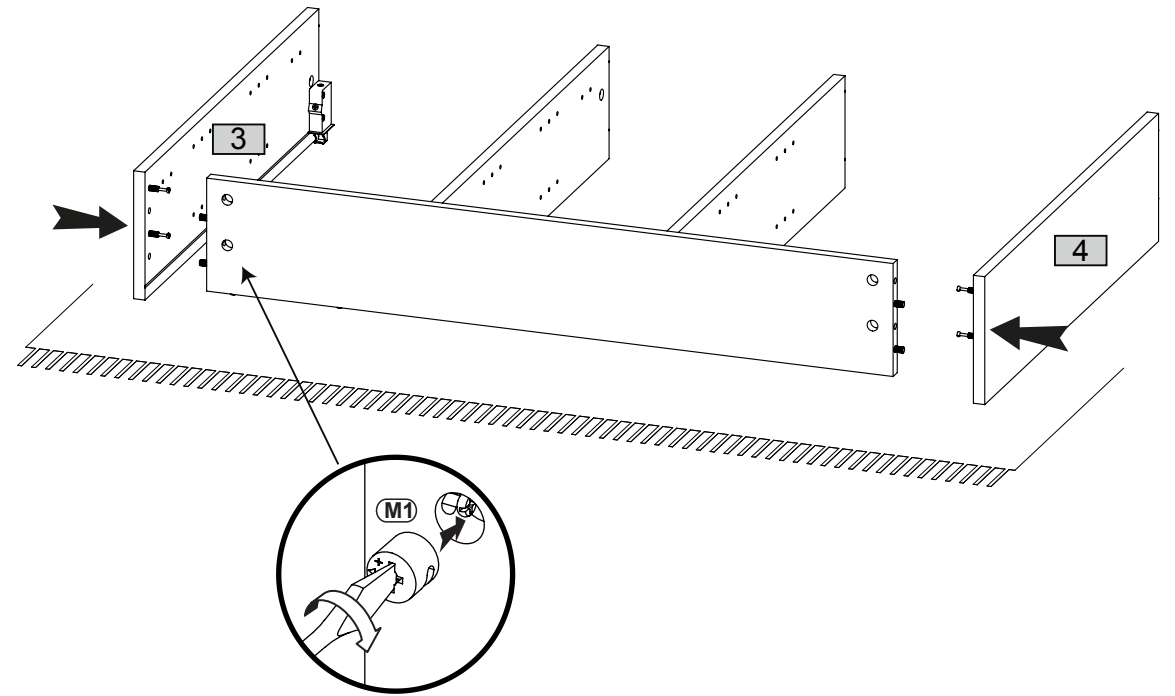

4

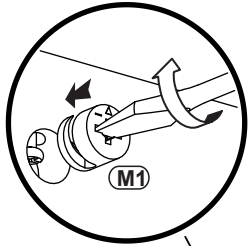

2

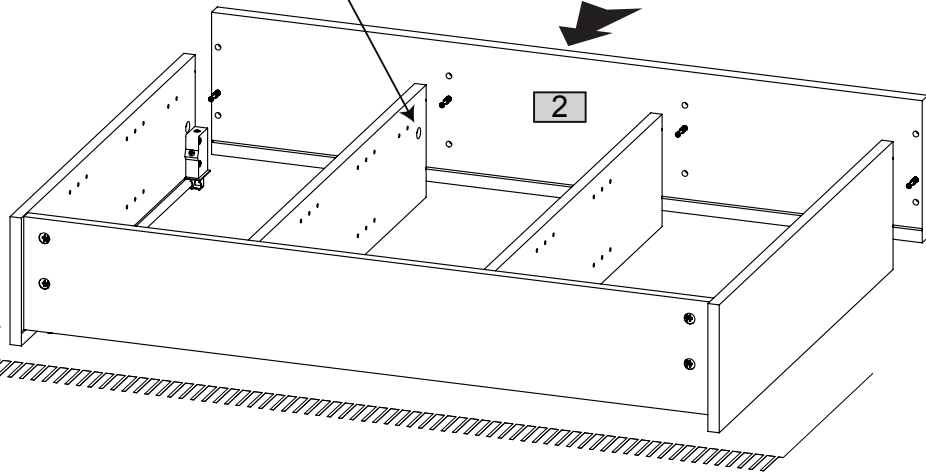

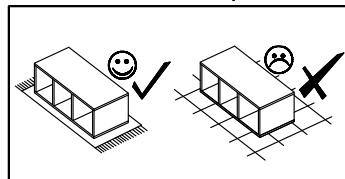
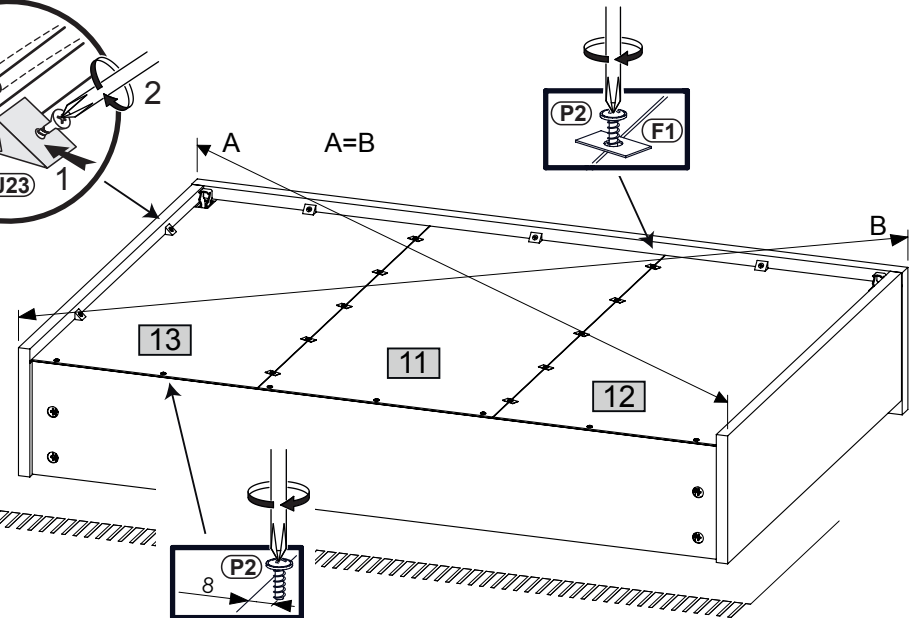
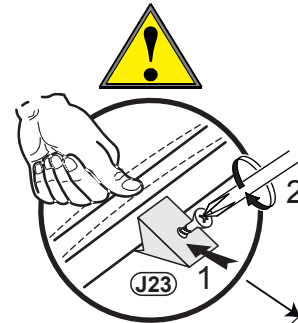
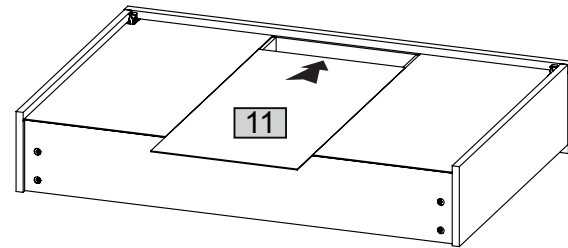
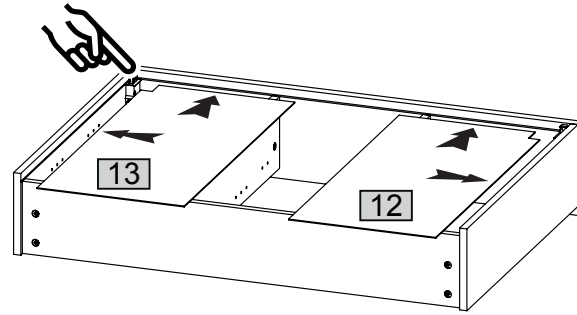
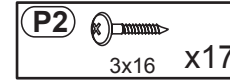
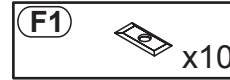
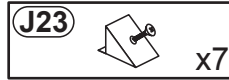

5

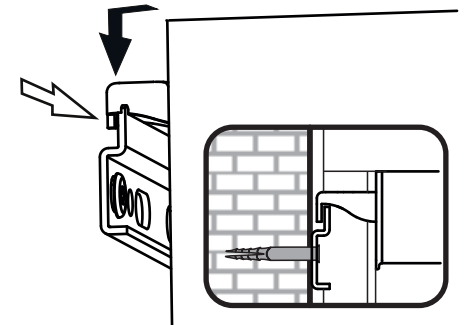
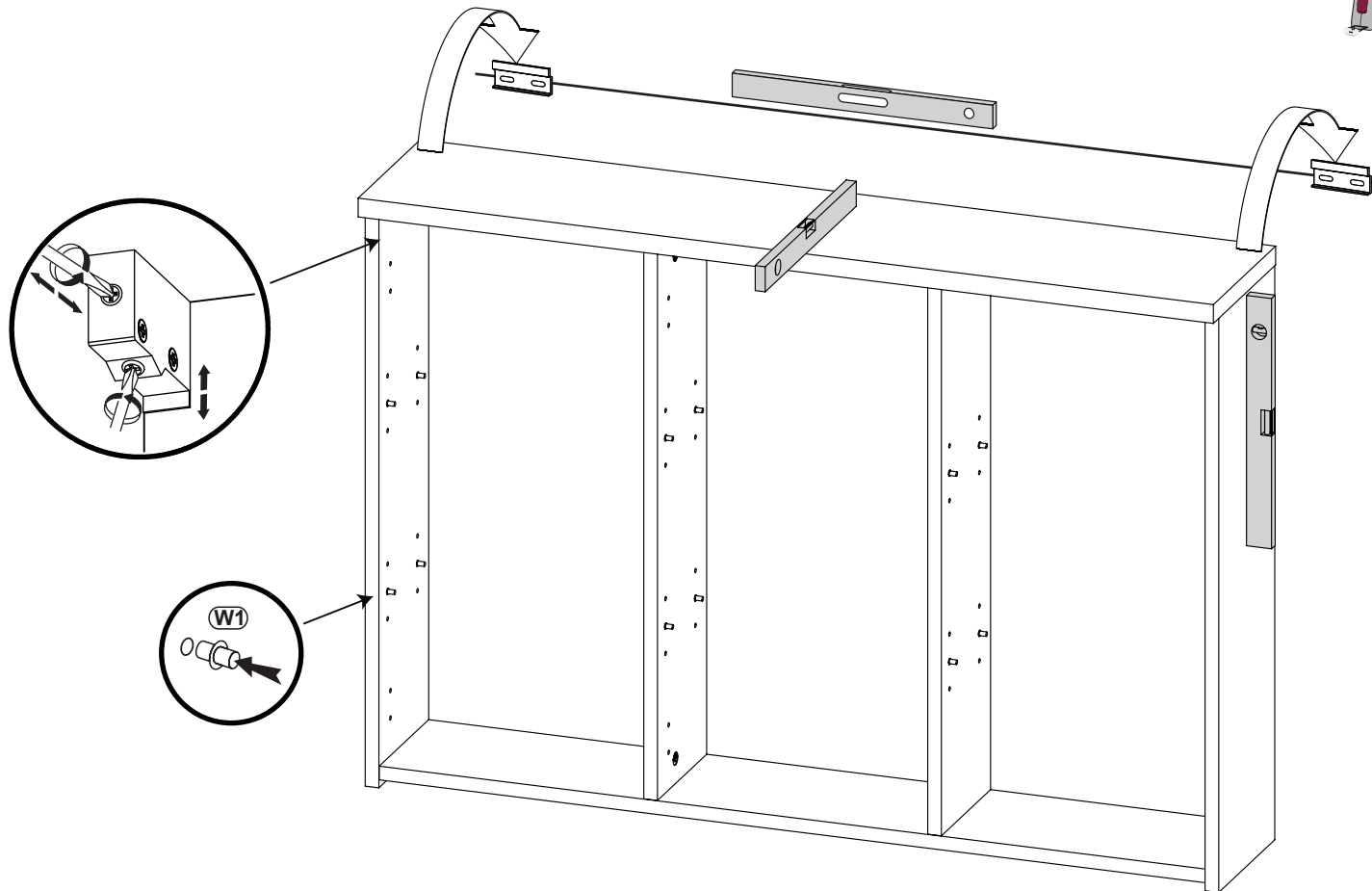
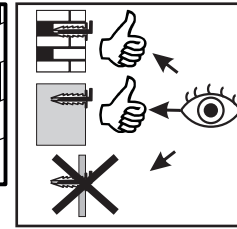
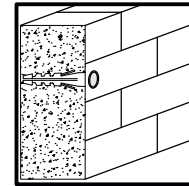
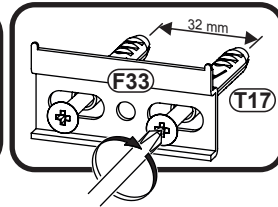
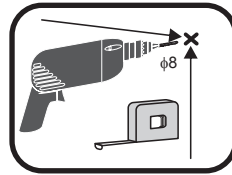
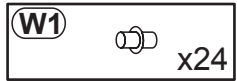
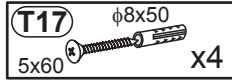
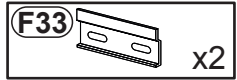

6



7

- Z2c  x4
- S9  4x16 x12
- Z3c  x2

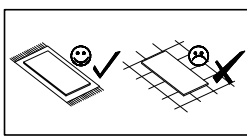
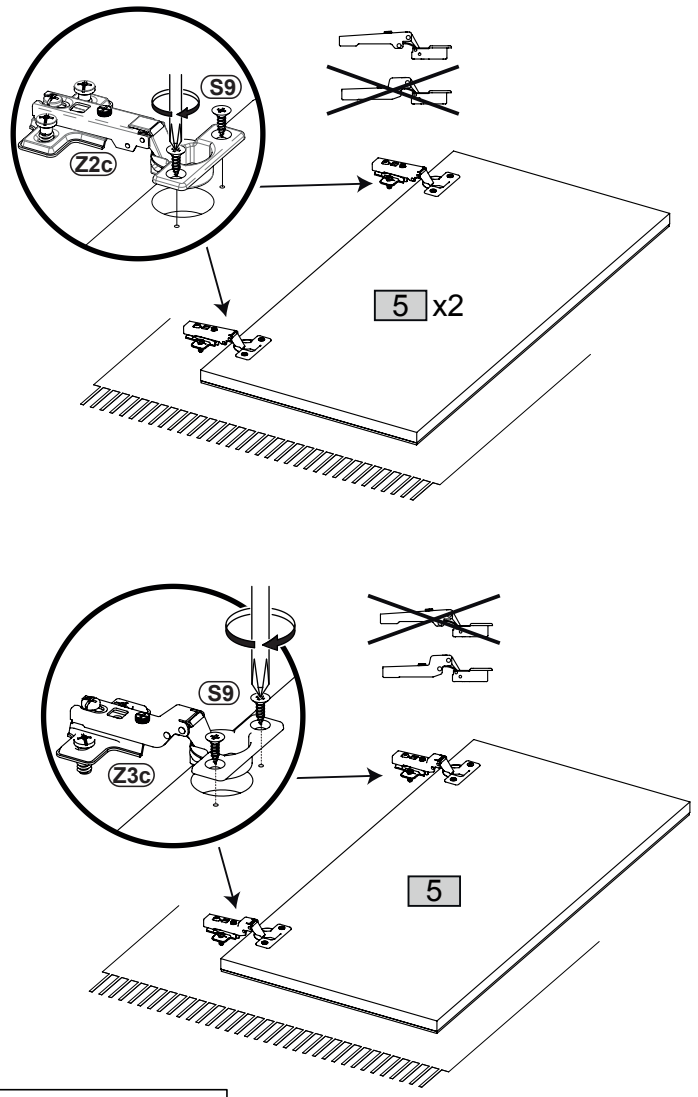

8

- C2  ϕ 20 x10

